

**DURA**<sup>®</sup>

---



**400 SERIES**

Product catalogue

Issue 24C

The very essence of Dura. This beautiful, simple design is the meeting point of form and function

Our flagship product, the 600 Series, has represented the absolute pinnacle of workshop furniture for over 25 years. Now, Dura has utilised every element of its design experience and manufacturing expertise to create an entirely new range of world-class furniture.

The 400 Series has been designed from the ground up to be simple.

**Simple to choose, simple to buy, and simple to install.**

The 400 Series revolves around the purchasing of combination packages.

This concept enables customers to choose the layout that best meets their needs, have their products delivered in a matter of days and installed within hours.



## Dura's world-class design expertise

When you invest in Dura furniture, you can be sure that you are buying something of real quality. Dura's award-winning equipment is used within the workshops of the most prestigious automotive brands worldwide – and for good reason.

We use the very latest manufacturing technology to assure you of consistent quality time after time, backed by Dura's legendary service and product guarantee.

In 1997, Dura transformed the automotive workshop with its revolutionary furniture system which, despite many copies, remains the premium system of choice. Think of a leading, prestigious automotive brand and the chances are that they either recommend or insist upon Dura.

400 SERIES

# 400 SERIES System Overview

Page **6-7** **A** Open-fronted and drawer base units

Page **8-9** **B** Under-bench mobile cabinet and trolley system

Page **10-11** **C** Door and waste management units



**D** Wall units Page **12-13**

**E** Back panels and accessories Page **14-15**

**F** Trunking Page **16**

## Longevity

- ✓ Painted in Architectural grade Anthracite Grey (RAL7016) textured paint
- ✓ Steel is pre-treated with anti-corrosive phosphate coating ahead of powder coating for a superior long-lasting finish
- ✓ Hard-wearing ABS plastic work surface, fitted to all base units as standard
- ✓ Compliant with ISO standards

## Flexibility

- ✓ 600, 900 and 1200mm range options
- ✓ Full height and low-level configuration options
- ✓ Key-to-door or key-to-suite (excluding D4UC065/95) locking options
- ✓ Height-adjustable internal shelves
- ✓ Alternative beech or stainless-steel worktops available

## Quality

- ✓ High-capacity shelving (20kg max. load)
- ✓ High-capacity drawer runners (60kg max. load)
- ✓ Foam-lined drawers
- ✓ All cabinet units supplied ready-assembled
- ✓ Integrated levelling system with adjustable feet
- ✓ Proudly designed and manufactured in Britain
- ✓ Includes 10 Year Guarantee\* (see page 27)

## Safety and Security

- ✓ Soft-close drawers
- ✓ Magnetic door closing mechanism ensures security
- ✓ Lockable doors and drawers
- ✓ Anti-tilt mechanism for mobile units
- ✓ Lockable castors



# Open-fronted and drawer base units

The 400 Series' comprehensive mix of base units provides the perfect foundation for every workspace configuration. The open-fronted base units offer a lower-cost easy-access solution for storage, with the option for additional shelves ensuring your requirements are met. The drawer units provide a range of drawer sizes, all foam-lined, which keep your valuable items secured under lock and key.



## Key Features

- ✓ Lockable 'soft close' drawers lined with foam
- ✓ High-capacity drawer runners (60kg max. load)
- ✓ High-capacity adjustable internal shelving (20kg max. load)
- ✓ Hard-wearing ABS plastic work surface fitted as standard to all base units
- ✓ Integrated levelling system with adjustable feet

Base units can be levelled with adjustable feet, that are accessed from above

## OPEN-FRONTED BASE UNITS

Open-fronted base units with an adjustable internal shelf.

W 600, 900 or 1200mm  
D 600mm  
H 950mm



**D4BU061**  
W 600mm



**D4BU091**  
W 900mm



**D4BU121**  
W 1200mm

## 2-DRAWER BASE UNITS

Lockable drawer units with 2 x extra large drawers with foam lining.

W 600 or 900mm  
D 600mm  
H 950mm



**D4DU062**  
W 600mm

Internal dimensions for drawers:  
W 480mm  
D 470mm  
H 416(184)mm

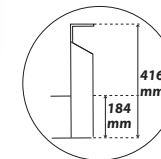

**D4DU092**  
W 900mm

Internal dimensions for drawers:  
W 780mm  
D 470mm  
H 416(184)mm

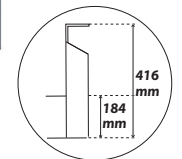

## 5-DRAWER BASE UNITS

Lockable drawer units with 2 x medium drawers and 3 x large drawers, all with foam lining.

W 600 or 900mm  
D 600mm  
H 950mm



**D4DU065**  
W 600mm

Internal dimensions for drawers:  
**Medium**  
W 480mm  
D 470mm  
H 78mm  
**Large**  
W 480mm  
D 470mm  
H 183mm



**D4DU095**  
W 900mm

Internal dimensions for drawers:  
**Medium**  
W 780mm  
D 470mm  
H 78mm  
**Large**  
W 780mm  
D 470mm  
H 183mm

# Under-bench mobile cabinet and trolley system

Transport tools to the task, then stow neatly back in place with the 400 Series bridging system. Configure areas for mobile cabinets or trolleys beneath an even, continuous worksurface to maximise usable space.

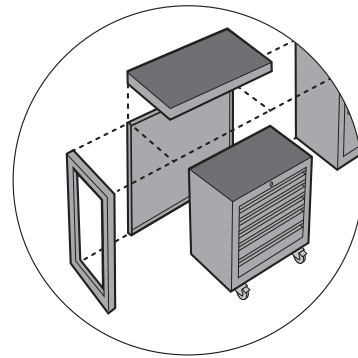

### Key features:

- ✓ Lockable 'soft close' drawers lined with foam
- ✓ Anti-tilt mechanism
- ✓ Lockable castors
- ✓ High-capacity drawer runners (60kg max. load)
- ✓ Front-facing pull handles
- ✓ ABS plastic fitted as standard to mobile cabinets and bridging units

BRIDGE SUPPORT

## UNDER-BENCH CABINETS

Mobile drawer cabinets to fit under bridging units. Contains 4x medium and 1x large foam-lined soft-close drawers. Includes front-facing pull handles and lockable castors.  
W 500 or 800mm, D 572mm, H 850mm



**D4UC065**  
W 500mm

Internal dimensions for drawers:  
**Medium**  
W 359mm  
D 464mm  
H 78mm  
**Large**  
W 359mm  
D 464mm  
H 183mm



**D4UC095**  
W 800mm

Internal dimensions for drawers:  
**Medium**  
W 659mm  
D 464mm  
H 78mm  
**Large**  
W 180mm  
D 464mm  
H 183mm

## UNDER-BENCH TROLLEYS

Trolleys with 3 fixed shelves to fit under bridging units. With lockable castors.  
W 520 or 820mm  
D 520mm  
H 838mm



**D4TR060**  
W 520mm



**D4TR090**  
W 820mm

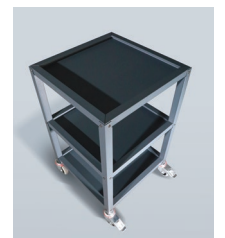

## BRIDGING UNITS

Designed to span gaps underneath the worktop between base units and/or bridge supports.  
D 600mm, H 50mm

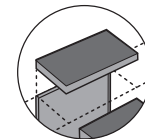

- D4BR060** W 600mm
- D4BR090** W 900mm
- D4BR120** W 1200mm

## INFILL PANELS

Rear cover panels beneath bridging units for a clean, concealed space.

### For base unit to base unit

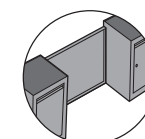

- D4BI060** W 600mm
- D4BI090** W 900mm
- D4BI120** W 1200mm

### For base unit to bridge support

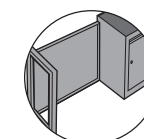

- D4BI061** W 560mm
- D4BI090** W 860mm
- D4BI121** W 1160mm

## BRIDGE SUPPORT

For a bridge unit configuration where no base unit can be attached to.

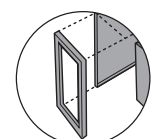

- D4BS001**  
W 40mm,  
D 600mm,  
H 900mm

# Door and waste management units

These spacious cabinets provide bulk storage and full-height organisation options under lock and key.

Door base units are fitted with a single adjustable shelf, with the option to add more, whilst tall closets can be fitted with up to three extra shelves and/or an optional coat rail.

The waste management unit houses a removable bin, glove dispenser and towel dispenser within two pull-out drawers.



## Key Features

- ✓ Lockable doors, with magnetic closing
- ✓ High load capacity shelving (20kg max.)
- ✓ High-capacity drawer runners (60kg max. load)
- ✓ ABS plastic work surface fitted to all base units as standard
- ✓ Capacity for additional shelves
- ✓ Coat rails can be mounted in the closet roof or to the underside of shelves
- ✓ Integrated levelling system with adjustable feet

## DOOR BASE UNITS

Base units with lockable doors and an adjustable internal shelf. Includes ABS plastic worktop.

W 600, 900 or 1200mm, D 600mm, H 950mm



**D4BU060**  
W 600mm



**D4BU090**  
W 900mm



**D4BU120**  
W 1200mm

## CLOSET UNITS

2m high units with lockable doors and an adjustable internal shelf.

W 600 or 900mm, D 600mm, H 2000mm



**D4CU060**  
W 600mm



**D4CU090**  
W 900mm

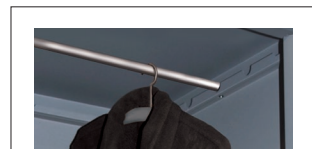

### COAT RAIL

Fits inside the closet or to the underside of shelves.

- D4CR060** for 600mm
- D4CR090** for 900mm

### ADDITIONAL SHELVES

A maximum of three additional shelves per closet unit.

- D4SH060** for 600mm
- D4SH090** for 900mm

## WASTE MANAGEMENT UNIT

Base unit with drawers for a removable wastebin, paper towels, and gloves. Includes ABS plastic work surface.

W 600mm, D 600mm, H 950mm



**D4BB060**



## Door and open-fronted wall units

Maximise the storage potential of your space with high-level 'wall' units, available in 600, 900, or 1200mm widths. These can be open-fronted or fitted with gas-strut doors.



These units are easily fitted to robust backstraps, which attach to lower base units to provide a freestanding solution, whilst lower back panels fit beneath for a continuous finish.

### Key Features

- ✓ Choice of 600, 900 and 1200mm widths
- ✓ Quick assembly onto backstraps
- ✓ Twin gas-struts for a vertically opening door
- ✓ Fixed internal shelf

### WALL UNITS WITH DOORS

High-level units with vertically opening doors and an internal shelf.



**D4WU060**  
W 600mm  
D 280mm  
H 550mm

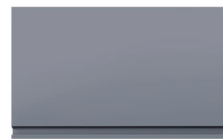

**D4WU090**  
W 900mm  
D 280mm  
H 550mm

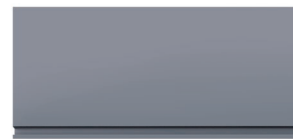

**D4WU120**  
W 1200mm  
D 280mm  
H 550mm

### OPEN-FRONTED WALL UNITS

High-level open fronted units with an internal shelf.



**D4WU061**  
W 600mm  
D 250mm  
H 550mm



**D4WU091**  
W 900mm  
D 250mm  
H 550mm



**D4WU121**  
W 1200mm  
D 250mm  
H 550mm

## Backstraps and sidestraps

2m high backstraps and sidestraps are used to attach wall units and back panels to base units.

**Backstraps** are made from galvanised steel and suitable for hidden fixing positions.

**Sidestraps** are painted to match the cabinets and back panels and so are suitable for fixing positions that are visible from the sides

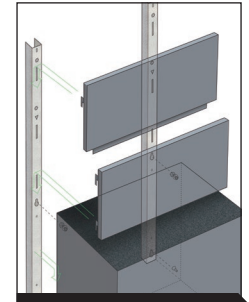
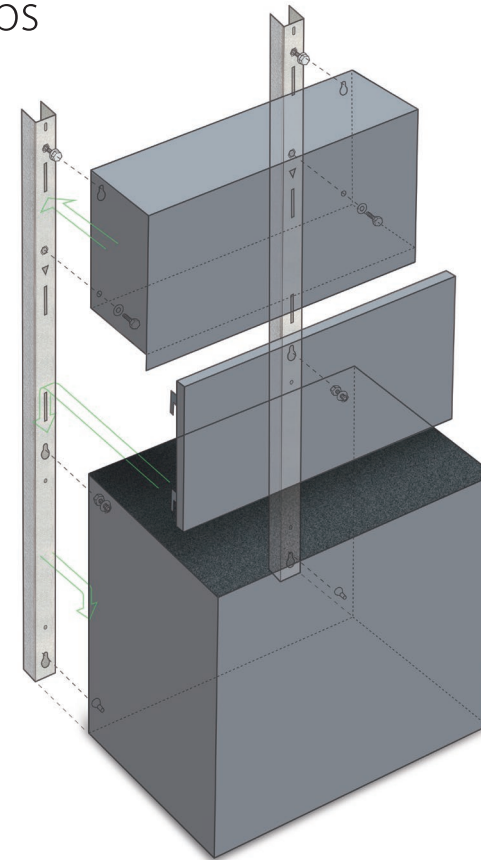

See page 14-15 for back panels

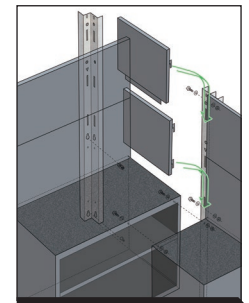

See page 18 for corner configuration

### BACKSTRAPS



**D4BK001**  
D 50mm backstrap in galvanised steel suitable for hidden positions for either side



**D4BK050**  
D 50mm sidetraps painted anthracite grey (RAL 7016) for either side



**D4BK002**  
D 100mm sidetraps painted anthracite grey (RAL 7016) for left-hand side



**D4BK003**  
D 100mm sidetraps painted anthracite grey (RAL 7016) for right-hand side

# Back panels and accessories

The 400 Series includes a selection of blank or square peg panels in the standard 600, 900 and 1200 widths to provide a neat, continuous backdrop for the cabinets. Panels slot onto backstraps and sidestraps which are attached to the base units for a quick, freestanding installation.

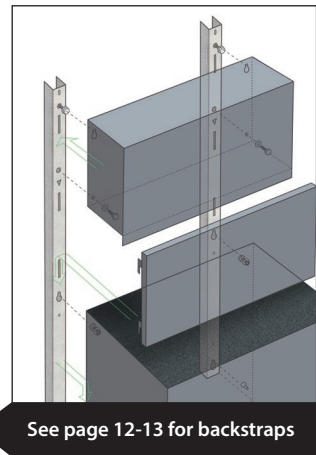
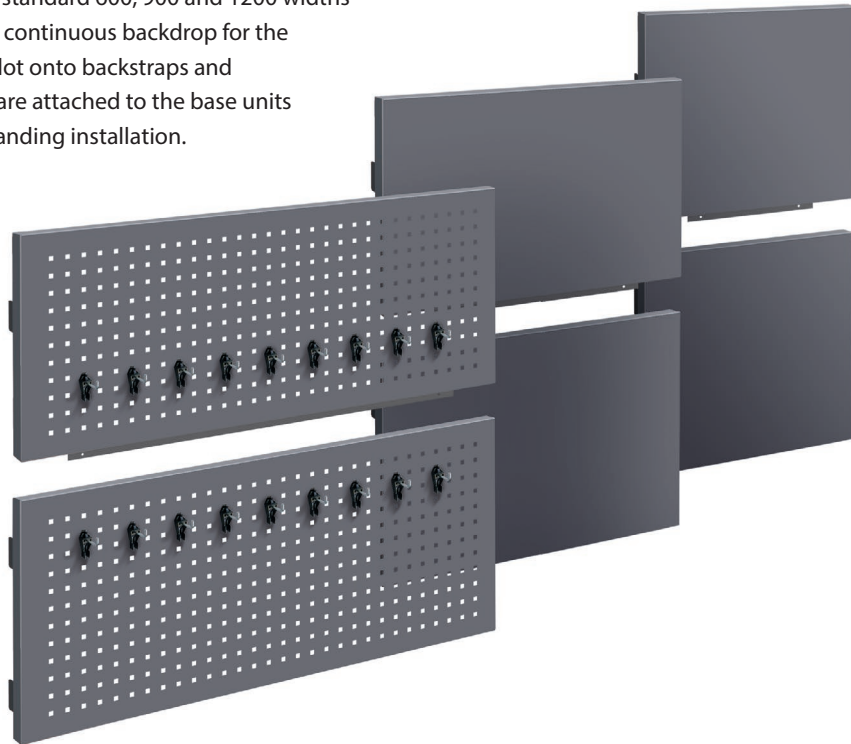

Back panels slot onto the backstrap system

## BLANK BACK PANELS

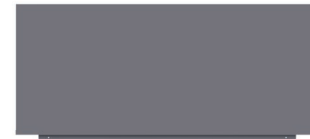

Upper blank panels, 505mm high

W 600mm **D4BP061**

W 900mm **D4BP091**

W 1200mm **D4BP121**



Lower blank panels, 545mm high

W 600mm **D4BP060**

W 900mm **D4BP090**

W 1200mm **D4BP120**

## PEG PANELS

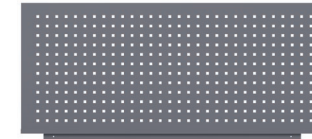

Upper peg panels, 505mm high

W 600mm **D4SQ061**

W 900mm **D4SQ091**

W 1200mm **D4SQ121**

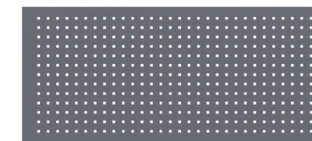

Lower peg panels, 545mm high

W 600mm **D4SQ060**

W 900mm **D4SQ090**

W 1200mm **D4SQ120**

## FOR CORNERS



Special corner upper blank panel

W 585mm

H 505mm

**D4BPC061**

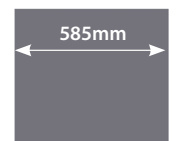

Special corner lower blank panel

W 585mm

H 545mm

**D4BPC060**

See page 18 for corner configuration

## PEG PANEL ACCESSORIES

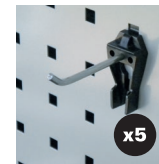

**SQR-001**

60mm single hooks (pack of 5)

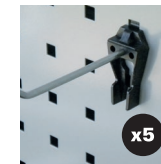

**SQR-002**

90mm single hooks (pack of 5)



**SQR-003**

30mm double hooks (pack of 3)



**SQR-004**

60mm double hooks (pack of 3)



**SQR-005**

25mm single hooks (pack of 5)

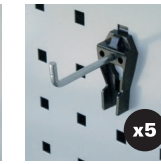

**SQR-006**

50mm single hooks (pack of 5)



**SQR-007**

75mm single hooks (pack of 5)

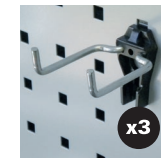

**SQR-008**

75mm hammer holders (pack of 3)

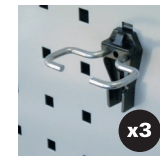

**SQR-009**

50mm pliers holders (pack of 3)

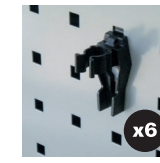

**SQR-010**

12mm spring clips (pack of 6)



**SQR-011**

24mm spring clips (pack of 6)

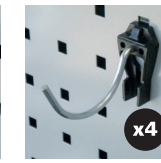

**SQR-012**

60mm drill holders (pack of 4)



## Trunking system

The trunking system allows power sockets to be mounted at a low level and angled for ease of use. Trunking sections are available at the standard 600mm, 900mm and 1200mm module widths and painted in the standard 400 Series Anthracite Grey (RAL7016) finish. The trunking sections, end plates and sockets are supplied as separate items for self assembly.

**All electrical work should be completed by a qualified electrician.**



**Twin double socket trunking**

- W 600mm** TRCUK061
- W 900mm** TRCUK091
- W 1200mm** TRCUK121



**TRC001**  
**End plate**



**MES-002SS**  
**Stainless steel double socket (UK)**

## Upstands

For installations **without** back panels, the 400 Series includes 150mm high upstands, to attach to the rear of base units. This provides a low barrier to reduce the risk of items rolling off and behind the cabinet.



**D4BP062**

- W 600mm**
- D 15mm**
- H 150mm**

**D4BP092**

- W 900mm**
- D 15mm**
- H 150mm**

**D4BP122**

- W 1200mm**
- D 15mm**
- H 150mm**

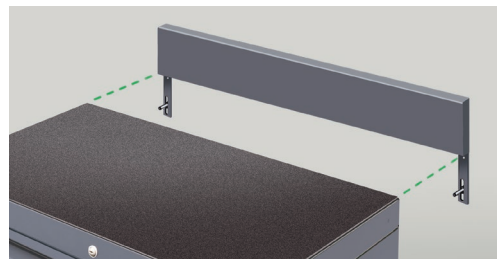

Attaches to rear of base units



Upstands can join with trunking system

## Workbenches

In addition to the range of base units, the 400 series includes a workbench designed primarily as a stand alone bench. This is available configured with a beech or stainless steel worksurface and painted to match the wider 400 series range. These workbenches have been designed with additional heavy-duty capacity for mounting of a vice – we do not recommend mounting vices to any other 400 Series products.



**D4WB121**

Workbench with a STAINLESS STEEL worktop

- W 1200mm**
- D 600mm**
- H 840mm**

**D4WB120**

Workbench with a BEECH worktop

- W 1200mm**
- D 600mm**
- H 840mm**



**D4BP122**

150mm upstand

Workbenches are suitable for vice mounting

Workbenches can be fitted with an upstand, between other 400 Series cabinets, but are not compatible with the back panel system

## Corner Configuration

The modularity of the 400 Series allows the building of a continuous run of base units and back panels around a corner. The special items used to achieve this are indicated below.

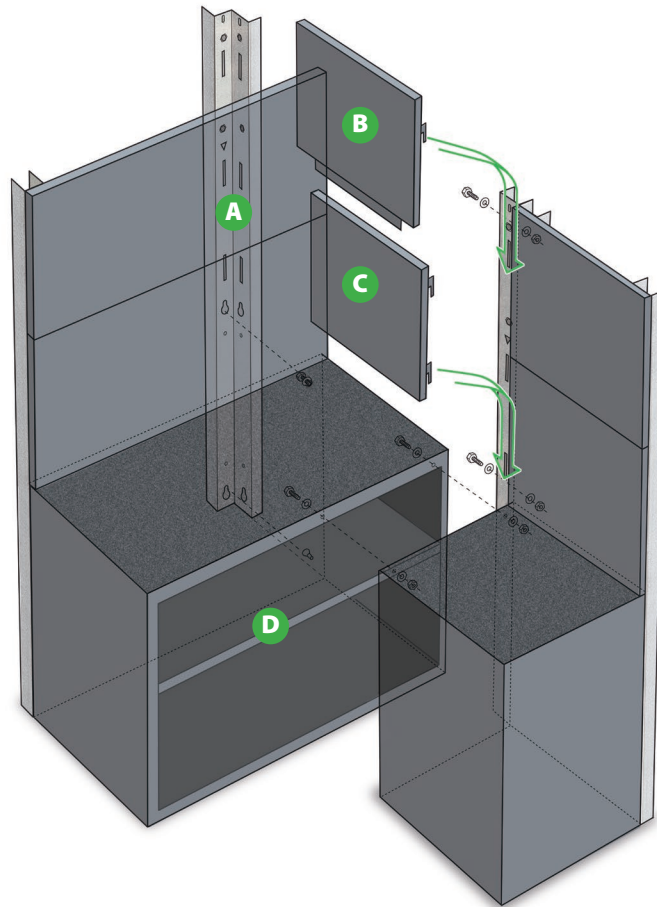

**A DFBK004**  
Corner backstrap in galvanised steel  
H 1965mm



**B D4BPC061**  
Special corner upper blank panel  
W 585mm  
D 15mm  
H 505mm



**C D4BPC060**  
Special corner lower blank panel  
W 585mm  
D 15mm  
H 545mm



**D D4BU121** (see page 7)  
1200mm open-fronted base unit  
W 1200mm  
D 600mm  
H 950mm

## Alternative worksurfaces

Alternative 40mm worksurfaces can be chosen instead of the standard ABS plastic fitted. These can be mounted on base units without back panels (1), or fitted projecting (2) where back panels are present.



### 40MM BEECH WORKTOPS

- W 600mm **D4WT060**
- W 900mm **D4WT090**
- W 1200mm **D4WT120**
- W 1500mm **D4WT150**
- W 1800mm **D4WT180**



Fitting position 1



Fitting position 2

### 40MM STAINLESS STEEL WORKTOPS

- W 600mm **D4ST060**
- W 900mm **D4ST090**
- W 1200mm **D4ST120**
- W 1500mm **D4ST150**
- W 1800mm **D4ST180**

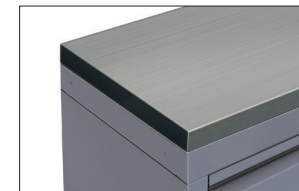

Fitting position 1

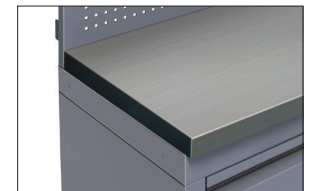

Fitting position 2

## Combination packages

The modularity of the 400 Series offers a wide range of possibilities, so we've gathered our most popular combinations as starting packages. These can be purchased as shown, or form the basis for a larger design.



### Low-Level Combination Package 1 D4CPL241

Overall dimensions:  
**W 2400mm, D 600mm, H 950mm**

**Package contains:**

- 900mm 5-drawer base unit **D4DU095**
- 600mm bridging unit **D4BR060**
- 600mm infill panel **D4BI060**
- 900mm base unit with doors **D4BU090**



### Low-Level Combination Package 2 D4CPL242

Overall dimensions:  
**W 3300mm, D 600mm, H 950mm**

**Package contains:**

- 900mm 5-drawer base unit **D4DU095**
- 900mm base unit with doors **D4BU090**
- 900mm bridging unit **D4BR090**
- 900mm infill panel **D4BI090**
- Waste management unit **D4BB060**



### Low-Level Combination Package 3 D4CPL243

Overall dimensions:  
**W 4200mm, D 600mm, H 950mm**

**Package contains:**

- 900mm 5-drawer base unit **D4DU095**
- 800mm under-bench cabinet **D4UC095**
- 900mm bridging unit **D4BR090**
- 900mm infill panel **D4BI090**
- Waste management base unit **D4BB060**
- 900mm 2-drawer base unit **D4DU092**
- 900mm base unit with doors **D4BU090**



### Low-Level Combination Package 4 D4CPL244

Overall dimensions:  
**W 3600mm, D 2100mm, H 950mm**

**Package contains:**

- 600mm base unit with door **D4BU060**
- 900mm 2-drawer base unit **D4DU092**
- 900mm 5-drawer base unit **D4DU095**
- Waste management base unit **D4BB060**
- 1200mm open-fronted base unit **D4BU121**
- 800mm under-bench cabinet **D4UC095**
- 900mm bridging unit **D4BR090**
- 900mm infill panel **D4BI090**
- Bridge support **D4BS001**

**High-Level Combination Packages** ▶



**High-Level  
Combination Package 1**  
**D4CPH241**

Overall dimensions:  
**W 2400mm, D 600mm, H 2000mm**

**Package contains:**

- 900mm 5-drawer base unit **D4DU095**
- 600mm bridging unit **D4BR060**
- 600mm infill panel **D4BI060**
- 900mm base unit with doors **D4BU090**
- 900mm wall units with door (x2) **D4WU090** (x2)
- 600mm wall unit with door **D4WU060**
- 900mm blank low back panel (x2) **D4BP090** (x2)
- 600mm blank low back panel **D4BP060**
- Backstrap (x4) **D4BK001** (x4)
- 50mm Sidestrap (x2) **D4BK050** (x2)

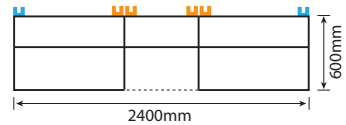

**High-Level  
Combination Package 2**  
**D4CPH242**

Overall dimensions:  
**W 3300mm, D 600mm, H 2000mm**

**Package contains:**

- 900mm 5-drawer base unit **D4DU095**
- 900mm base unit with doors **D4BU090**
- 900mm bridging unit **D4BR090**
- 900mm infill panel **D4BI090**
- Waste management base unit **D4BB060**
- 900mm wall unit with door (x3) **D4WU090** (x3)
- 600mm wall unit with door **D4WU060**
- 900mm blank low back panel (x3) **D4BP090** (x3)
- 600mm blank low back panel **D4BP060**
- Backstrap (x6) **D4BK001** (x6)
- 50mm Sidestrap (x2) **D4BK050** (x2)

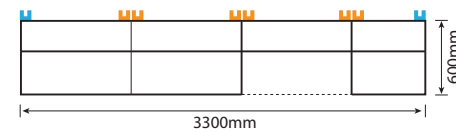

**High-Level  
Combination Package 3**  
**D4CPH243**

Overall dimensions:  
**W 4200mm, D 600mm, H 2000mm**

**Package contains:**

- 900mm 5-drawer base unit **D4DU095**
- 800mm under-bench cabinet **D4UC095**
- 900mm bridging unit **D4BR090**
- 900mm infill panel **D4BI090**
- Waste management base unit **D4BB060**
- 900mm 2-drawer base unit **D4DU092**
- 900mm closet unit **D4CU090**
- 900mm wall unit with door (x3) **D4WU090** (x3)
- 600mm wall unit with door **D4WU060**
- 900mm blank low back panel (x3) **D4BP090** (x3)
- 600mm blank low back panel **D4BP060**
- Backstrap (x7) **D4BK001** (x7)
- 50mm Sidestrap (x2) **D4BK050** (x2)

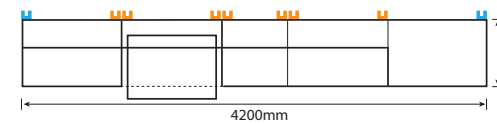

**High-Level  
Combination Package 4**  
**D4CPH244**

Overall dimensions:  
**W 3600mm, D 2100mm, H 2000mm**

**Package contains:**

- 600mm closet unit **D4CU060**
- 900mm 2-drawer base unit **D4DU092**
- 900mm 5-drawer base unit **D4DU095**
- Waste management base unit **D4BB060**
- 1200mm open-fronted base unit **D4BU121**
- 800mm under-bench cabinet **D4UC095**
- 900mm bridging unit **D4BR090**
- 900mm infill panel **D4BI090**
- Bridge support **D4BS001**
- 900mm wall unit with door (x3) **D4WU090** (x3)
- 600mm wall unit with door **D4WU060**
- 900mm blank low back panel (x3) **D4BP090** (x3)
- 600mm blank low back panel **D4BP060**
- 1200mm blank low back panel **D4BP120**
- 1200mm blank high back panel **D4BP121**
- Corner low back panel **D4BPC060**
- Corner high back panel **D4BPC061**
- Backstrap (x9) **D4BK001** (x9)
- Corner backstrap **D4BK004**
- 50mm Sidestrap (x2) **D4BK050** (x2)

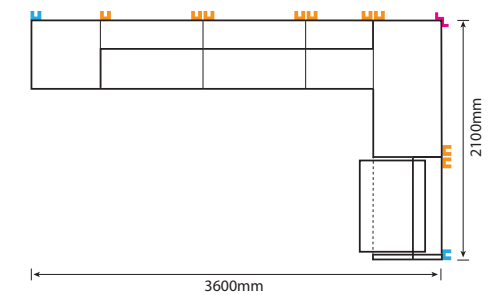

## Complementary products

Dura offers a range of products often requested by clients for use with the modular furniture system, outlined below. **Visit our website for further details.**

### TOOLS AND TOOL CONTROL FOAM

Dura offers sets of professional-quality tools in custom-cut control foam to fit Dura storage cabinets. These sets contain everything required by technicians for modern workshop servicing, covered by a tool lifetime guarantee. Dura can also organise tool sets to meet corporate standards.

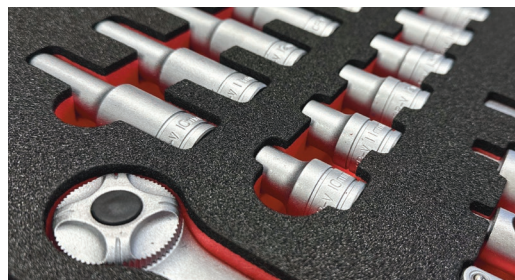

### PVC FLOOR TILES

Bare concrete floors create problems with cracking, dust, and cold. That's why Dura offers a range of PVC interlocking floor tiles as a convenient solution. These tiles are easy to lay without the need for gluing and are available in textured or studded finish, in a variety of colours.

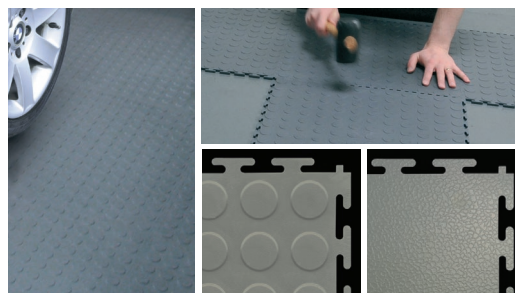

### DURA STOREPANEL™ WALL SYSTEM

Clear clutter off the floor and onto the walls with StorePanel™ – the ultimate flexible wall-mounted storage solution. These tough PVC panels provide the perfect storage solution for bulky awkward items that don't belong in cupboards. Once in place, you simply 'clip-on' the hooks and baskets, wherever you wish, then, move them around – no further fixing holes required!



## Designed with self-installation in mind...

The 400 series has been created to make installation well within the capabilities of a customer with basic DIY experience.

Unlike many storage systems, Dura 400 Series cabinets are **supplied ready assembled**, so installation requires only bolting and slot assembly for most configurations.

Printed installation instructions are provided with all products.





For those looking for peace of mind when fitting their 400 Series furniture, or who are purchasing as part of a larger project, we offer a complete **professional installation service**.

Our experienced team have worked on major flagship commercial projects around the world, so you are in good hands. Our team help with unpacking and assembly, ensuring everything is fitted and levelled perfectly... and all rubbish tidied away.

Professional Installation for 400 Series is priced based on your location and individual project requirements, so for a quotation, **please contact us on 01280 706050.**

## Dura's professional installation service

## Proudly made in Britain

Award-winning cabinets don't happen by accident. Dura boasts one of the world's most advanced sheet metal manufacturing facilities at its plant in Plymouth, with a highly skilled team to match. We have the very latest machinery from laser cutting, punch presses and press brakes, to CNC panel benders.

Dura can assure you of consistent quality, time after time. Our machines can also run on 'lights out' mode overnight for ultimate efficiency.

Not only do Dura's facilities produce the cabinetry with precision, but our skilled teams finish the assembly by hand. This hand finished touch uses only the best components for smooth operation, longevity of the product, and an additional stage of quality control checking. Our production teams operate within the strict standards demanded by our ISO-9001 and ISO-14001 accreditations.

You can be confident that no other company can match our experience or expertise when it comes to your workshop – we were the first company to design and manufacture integrated workshop furniture for which we have won 3 national and international awards.



MEMBER  
SINCE 2014



**MADE IN  
BRITAIN**

The Official Mark  
for British  
Manufacturing



## THE DURA PRODUCT GUARANTEE

Our guarantee covers the cost of spare parts and labour for the repair or replacement of Dura components for 10 years from the date of purchase by its first user.

For the full terms of our guarantee and repair procedures, please contact us on 01280 706050.

# DURA<sup>®</sup>

---



Dura Limited  
St James Road, Brackley  
Northants NN13 7XY

tel +44 (0) 1280 706050  
fax +44 (0) 1280 700444

email [info@dura.co.uk](mailto:info@dura.co.uk)  
web [www.dura.co.uk](http://www.dura.co.uk)

Due to our policy of continuous improvement,  
we reserve the right to alter specifications  
and prices without prior notice.

